

RACCORDERIA ZINCATA
GALVANIZED FITTINGS



omec

Art. 240 MANICOTTO RIDOTTO F.F. REDUCING SOCKET F.F.



M Fe 42

Zincato bianco



Buste PLT



Scatole di cartone

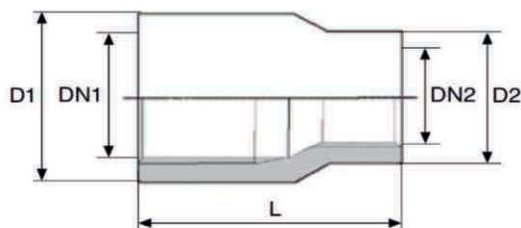

CODE	CONF.	DN1 X DN2	D1 mm X D2 mm	L mm	€
240C1418	100	1/4" x 1/8"	18 x 15	22	1,733
240C3818	100	3/8" x 1/8"	20 x 15	24	1,704
240C3814	100	3/8" x 1/4"	20 x 18	22	1,163
240C1214	100	1/2" x 1/4"	24 x 18	27	2,211
240C1238	100	1/2" x 3/8"	24 x 21	25,5	1,114
240C3414	100	3/4" x 1/4"	30 x 18	24	4,067
240C3438	100	3/4" x 3/8"	30 x 22	24	3,468
240C3412	100	3/4" x 1/2"	30 x 26	27	1,796
240C1380	100	1" x 3/8"	38 x 20	30	3,787
240C1120	100	1" x 1/2"	38 x 26	30	3,733
240C1340	100	1" x 3/4"	38 x 30	30	3,364
240C1143	50	1.1/4" x 1"	46 x 42	33,5	11,384

Art. 241 RIDUZIONE ESAGONALE M.F. HEXAGONAL REDUCER M.F.



M Fe 42

Zincato bianco



Buste PLT



Scatole di cartone

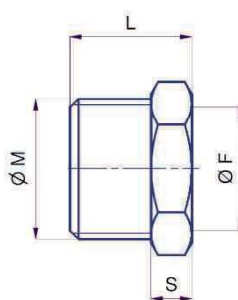
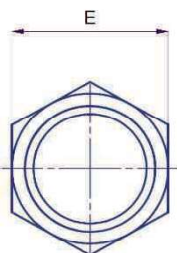

CODE	CONF.	M X F	E mm	L mm	S mm	€
241C1418	100	1/4" x 1/8"	16	16	5	0,848
241C3818	100	3/8" x 1/8"	19	17	6	1,674
241C3814	100	3/8" x 1/4"	19	17	6	0,519
241C1218	100	1/2" x 1/8"	22	21	7	1,185
241C1214	100	1/2" x 1/4"	22	21	7	0,666
241C1238	100	1/2" x 3/8"	22	21	7	0,553
241C3414	100	3/4" x 1/4"	27	21	7	2,770
241C3438	100	3/4" x 3/8"	27	21	7	1,023
241C3412	100	3/4" x 1/2"	27	21	7	0,745
RIDUZIONI TORNITE						
241C1140	100	1" x 1/4"	34	21	7	2,385
241C1380	100	1" x 3/8"	34	21	7	2,421
241C1120	100	1" x 1/2"	34	21	7	1,503
241C1340	100	1" x 3/4"	34	21	7	1,867
241C1412	50	1.1/4" x 1/2"	42	23	7	5,878
241C1434	50	1.1/4" x 3/4"	42	23	7	4,876
241C1141	50	1.1/4" x 1"	42	23	7	6,805
241C1122	50	1.1/2" x 1/2"	50	25	7	23,874
241C1123	50	1.1/2" x 3/4"	50	25	7	23,878
241C1121	50	1.1/2" x 1"	50	25	7	23,882
241C1124	50	1.1/2" x 1.1/4"	50	25	7	23,871
241C2120	25	2" x 1/2"	60	27	7	25,074
241C2340	25	2" x 3/4"	60	27	7	25,074
241C2100	25	2" x 1"	60	27	7	25,074
241C2114	25	2" x 1.1/4"	60	27	7	26,269
241C2112	25	2" x 1.1/2"	60	27	7	26,269

Art. 245 NIPPLO ESAGONALE RIDOTTO M.M.
HEXAGONAL REDUCING NIPPLE M.M.

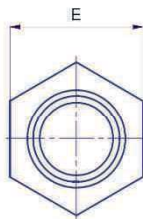
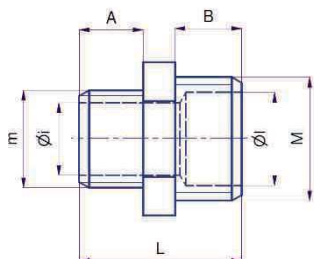
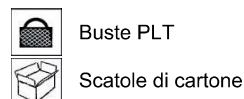

CODE	CONF.	M X E	B mm	A mm	E mm	L mm	€
245C1418	100	1/4" x 1/8"	10	10	9	25	1,100
245C3818	100	3/8" x 1/8"	10	10	17	24,5	1,723
245C3814	100	3/8" x 1/4"	11,5	10	19	26,5	0,814
245C1218	100	1/2" x 1/8"	11	11	22	27	2,069
245C1214	100	1/2" x 1/4"	13,5	10	22	29	1,176
245C1238	100	1/2" x 3/8"	13,5	11	22	30	0,731
245C3414	100	3/4" x 1/4"	12,5	11	27	31	3,134
245C3438	100	3/4" x 3/8"	13,5	13,5	27	34	1,957
245C3412	100	3/4" x 1/2"	13,5	13,5	27	34	1,302

RIDUZIONI TORNITE

245C1140	100	1" x 1/4"	16,5	14	34	39	5,725
245C1380	100	1" x 3/8"	16,5	14	34	39	7,246
245C1120	100	1" x 1/2"	14,5	13,5	34	34,5	3,431
245C1340	100	1" x 3/4"	14,5	13,5	34	34,5	2,188
245C1144	50	1.1/4" x 1/4"	16	11	42	34	7,516
245C1148	50	1.1/4" x 3/8"	16	11	42	34	7,529
245C1142	50	1.1/4" x 1/2"	16	12	42	35	7,536
245C1143	50	1.1/4" x 3/4"	16	13	42	35	7,542
245C1141	50	1.1/4" x 1"	16	15	42	38	9,573
245C1128	50	1.1/2" x 3/8"	18	11	50	36	22,678
245C1122	50	1.1/2" x 1/2"	18	12	50	37	22,678
245C1123	50	1.1/2" x 3/4"	18	12	50	37	22,678
245C1121	50	1.1/2" x 1"	18	15	50	40	22,678
245C1124	50	1.1/2" X 1.1/4"	18	16	50	41	23,545
245C2120	25	2" X 1/2"	18	12	60	36	33,410
245C2340	25	2" X 3/4"	18	12	60	37	33,410
245C2100	25	2" X 1"	18	14	60	37	33,410
245C2114	25	2" X 1.1/4"	18	18	60	41	35,798
245C2112	25	2" X 1.1/2"	18	18	60	43	38,179

Art. 246 PROLUNGA RIDOTTA F.M.
REDUCING EXTENSION F.M.

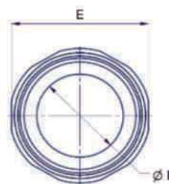
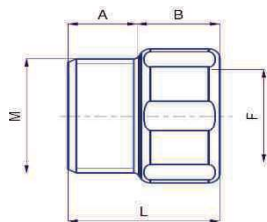
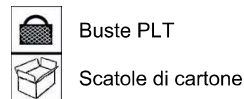

CODE	CONF.	F x M	B mm	A mm	E mm	L mm	€
246C1418	100	1/4" X 1/8"	10	10	17	24	1,838
246C3818	100	3/8" X 1/8"	10	10	17	25	1,820
246C3814	100	3/8" X 1/4"	10	10	20	22	0,966
246C3812	100	1/2" x 3/8"	11,5	11,5	24	24	0,728
246C1214	100	1/2" X 1/4"	10	10	24	25	1,348
246C3438	100	3/4" X 3/8"	13	13	30	28	1,995
246C3412	100	3/4" X 1/2"	12	12	30	27	1,179

PROLUNGHE TORNITE

246C1380	100	1" X 3/8"	15	15	38	30	6,014
246C1120	100	1" X 1/2"	14,5	14,5	38	29,5	7,169
246C1340	100	1" X 3/4"	14,5	14,5	38	29,5	6,090
246C1141	50	1.1/4" X 1"	15	15	50	33	14,314

Art. 280 NIPPLO ESAGONALE M.M. HEXAGONAL NIPPLE M.M.

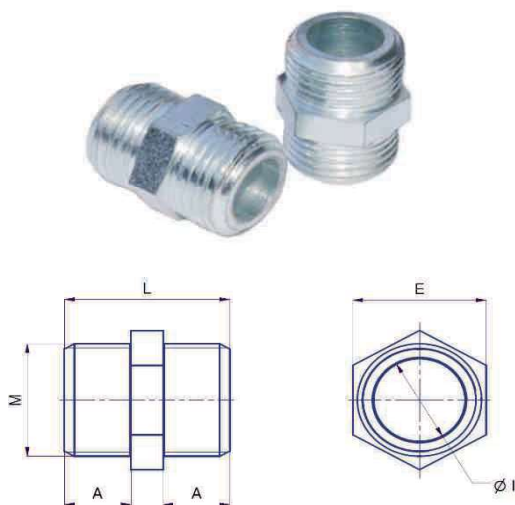

M Fe 42



Zincato bianco



Buste PLT



Scatole di cartone

CODE	CONF.	M	A mm	L mm	E mm	€
280C1800	100	1/8"	10	25	15	1,591
280C1400	100	1/4"	10	24,5	15	0,656
280C3800	100	3/8"	11,5	29	19	0,592
280C1200	100	1/2"	13,5	34	22	0,733
280C3400	100	3/4"	13,5	33,5	27	0,882
TORNITI						
280C1000	100	1"	14	34,5	34	3,145
280C1140	50	1.1/4"	16	39	42	5,800
280C1120	50	1.1/2"	18	43	50	16,998
280C2000	25	2"	18	43	60	25,847

Art. 280T NIPPLO M.M. CON BATTUTA PIANA TORNITA NIPPLE M.M. WITH TURNED SEAT



M Fe 42



Zincato bianco



Buste PLT



Scatole di cartone

CODE	CONF.	M	A mm	L mm	E mm	€
280T12PI	100	1/2"	13,5	34	22	2,374

Art. 290 TAPPO M. CONICO CON QUADRO PLUG M. WITH SQUARE NUT

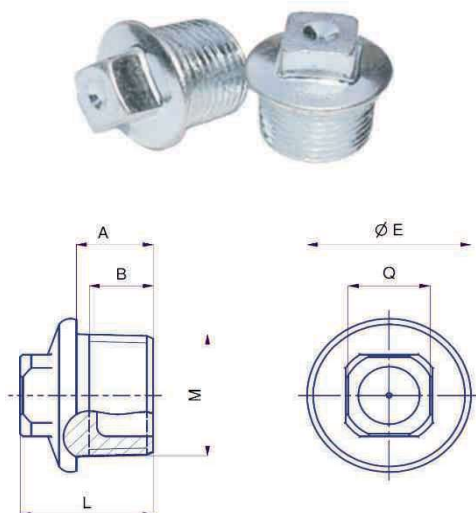

M Fe 42



Zincato bianco



Buste PLT



Scatole di cartone

CODE	CONF.	M	A mm	B mm	E mm	L mm	Q mm	€
290C1400	100	1/4"	12	10	15	19	9	0,583
290C3800	100	3/8"	12	10	21	21	10	0,841
290C1200	100	1/2"	13	11	25	22	12	0,881
290C3400	100	3/4"	15	12,5	32	26	17	1,184
290C1000	100	1"	16	13	40	28	19	1,859

Art. 292 TAPPO M. ESAGONALE
HEXAGONAL M. PLUG

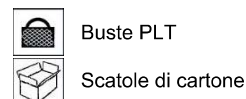
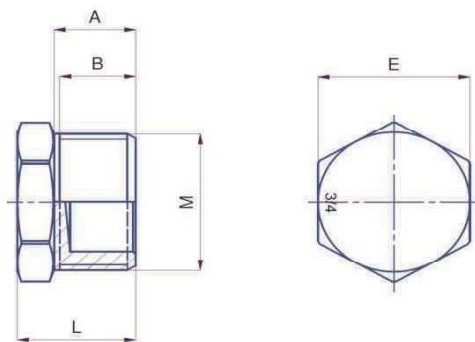

CODE	CONF.	M	A mm	B mm	E mm	L mm	€
292C1800	100	1/8"	10	9	14	14	1,030
292C1400	100	1/4"	10,5	10	15	15,5	0,497
292C3800	100	3/8"	11,3	11	19	17,5	0,510
292C1200	100	1/2"	13,5	13	22	20	0,558
292C3400	100	3/4"	14,5	14	27	21	0,814
TORNITI							
292C1000	100	1"	14	12	34	21	1,502
292C1140	50	1.1/4"	16	14	42	23	10,753
292C1120	50	1.1/2"	18	16	50	25	17,605
292C2000	25	2"	18	16	60	25	18,747

Art. 300 TAPPO F. ESAGONALE
HEXAAGONAL F. CAPS

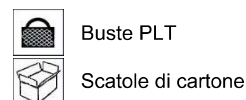
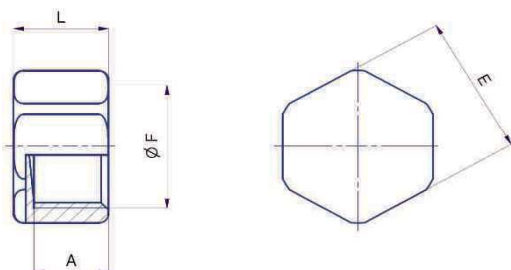

CODE	CONF.	F.	L mm	A mm	E mm	€
300C1800	100	1/8"	12	7	14	0,974
300C1400	100	1/4"	15	10,5	20	0,702
300C3800	100	3/8"	15	10,5	20	0,584
300C1200	100	1/2"	24	12,5	24	0,606
300C3400	100	3/4"	30	14,5	30	0,786
TORNITI						
300C1000	100	1"	22	16	38	2,371
300C1140	50	1.1/4"	22	16	50	14,138
300C1120	50	1.1/2"	22	16	60	17,823

Art. 310 GHIERA - CONTRODADO
LOCK NUT

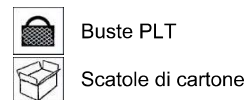
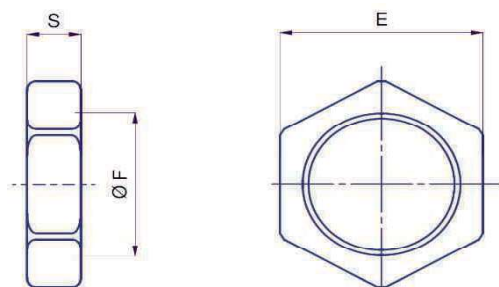

CODE	CONF.	F	E mm	S mm	€
310C1800	100	1/8"	17	5	1,716
310C1400	100	1/4"	19	5	1,020
310C3800	100	3/8"	22	7,5	0,676
310C1200	100	1/2"	27	8	0,914
310C3400	100	3/4"	34	9	1,402
TORNITE					
310C1000	100	1"	42	10	3,810
310C1140	50	1.1/4"	50	10	9,542
310C1120	50	1.1/2"	60	10	10,734
310C2000	25	2"			A richiesta

Art. 520 PROLUNGA M.F. EXTENSION M.F.



M Fe 42

Zincato bianco



Buste PLT



Scatole di cartone

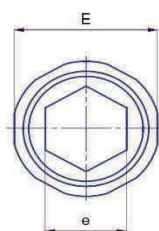
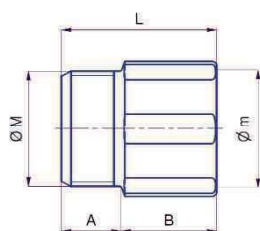

CODE	CONF.	M F	B mm	A mm	L mm	E mm	€
520C1415	100	1/4"	15	10	25	20	1,626
520C3810	100	3/8"	10	10	22	20	0,526
520C3815	100	3/8"	15	10	25	20	0,553
520C3820	100	3/8"	20	10	30	20	0,633
520C3825	100	3/8"	25	10	35	20	0,993
520C3830	100	3/8"	30	10	40	20	1,031
520C3840	100	3/8"	40	10	50	20	2,154
520C3850	100	3/8"	50	10	60	20	2,720
520C1210	100	1/2"	10	11,5	23,5	24	0,484
520C1215	100	1/2"	15	11,5	26,5	24	0,474
520C1220	100	1/2"	20	11,5	31,5	24	0,576
520C1225	100	1/2"	25	11,5	36,5	24	0,784
520C1230	100	1/2"	30	11,5	41,5	24	0,863
520C1240	100	1/2"	40	11,5	51,5	24	1,837
520C1250	100	1/2"	50	11,5	61,5	24	1,891
520C3410	100	3/4"	10	12,5	24,5	30	0,938
520C3415	100	3/4"	15	12,5	27,5	30	1,064
520C3420	100	3/4"	20	12,5	32,5	30	1,108
520C3425	100	3/4"	25	12,5	37,5	30	1,653
520C3430	100	3/4"	30	12,5	42,5	30	1,784
520C3440	50	3/4"	40	12,5	52,5	30	3,819
520C3450	50	3/4"	50	12,5	62,5	30	4,382
PROLUNGHE TORNITE							
520C1150	50	1"	15	15	30	38	2,739
520C1200	25	1"	20	15	35	38	2,909
520C125X	25	1"	25	15	40	38	3,598
520C1300	25	1"	30	15	45	38	4,519
520C1400	25	1"	40	15	55	38	5,636
520C1500	25	1"	50	15	65	38	6,630
520C1142	25	1.1/4"	18	15	33	50	11,853

Art. 531 NIPPOLO M. TUTTO FILETTO ALL THREADED M. NIPPLE



M Fe 42

Zincato bianco



Buste PLT



Scatole di cartone

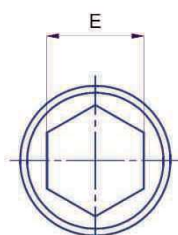
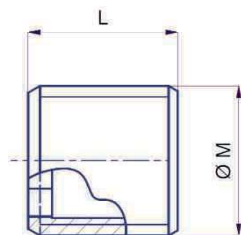

CODE	CONF.	M	L mm	E mm	€
531C3800	100	3/8"	22	9	1,372
531C1200	100	1/2"	25	13	0,568
531C3400	100	3/4"	25	16	0,929
531C1000	100	1"	30	20	1,613
531C1140	10	1.1/4"	40	31,5	2,398
531C1120	10	1.1/2"	42	37,5	2,641
531C2000	10	2"	43	49	6,153