

TRONCHETTI E BARILOTTI  
*STUB ENDS EXTENSION SCREWS*



**omec**

## Art. 40 TRONCHETTI BLACK STUB ENDS



Tubo laminato EN 10255. Normale UNI 339 - 7/1 per tubazioni a tenuta sul filetto.  
A richiesta si eseguono con filettatura cilindrica per tubazioni non a tenuta  
sul filetto ISO 228 - UNI 338.

**M** Fe 37 - EN 10255



Neri

**N** EN 10255 - Filetto ISO 7/1



Scatole di cartone

Si eseguono misure e lunghezze a richiesta non elencate nelle seguenti tabelle.

CODE	CONF.	DN	TYPE	LUNGH. mm	€
40C38100	10	10	3/8"	100	0,816
40C38150	10	10	3/8"	150	1,090
40C38200	10	10	3/8"	200	1,499
40C38250	10	10	3/8"	250	1,771
40C38300	10	10	3/8"	300	2,180
40C12100	10	15	1/2"	100	0,818
40C12150	10	15	1/2"	150	1,090
40C12200	10	15	1/2"	200	1,463
40C12250	10	15	1/2"	250	1,822
40C12300	10	15	1/2"	300	2,154
40C34100	10	20	3/4"	100	0,999
40C34150	10	20	3/4"	150	1,338
40C34200	10	20	3/4"	200	1,771
40C34250	10	20	3/4"	250	2,065
40C34300	10	20	3/4"	300	2,373
40C11000	10	25	1"	100	1,349
40C11500	10	25	1"	150	1,947
40C12000	10	25	1"	200	2,408
40C125X0	10	25	1"	250	2,877
40C13000	10	25	1"	300	3,381
40C11410	10	32	1.1/4"	100	1,664
40C11415	10	32	1.1/4"	150	2,342
40C11420	10	32	1.1/4"	200	2,921
40C11425	10	32	1.1/4"	250	3,523
40C11430	10	32	1.1/4"	300	4,259
40C11210	10	40	1.1/2"	100	2,029
40C11215	10	40	1.1/2"	150	2,854
40C11220	10	40	1.1/2"	200	3,546
40C11225	10	40	1.1/2"	250	4,371
40C11230	10	40	1.1/2"	300	5,129
40C21000	10	50	2"	100	2,587
40C21500	10	50	2"	150	3,590
40C22000	10	50	2"	200	4,594
40C22500	10	50	2"	250	5,642
40C23000	10	50	2"	300	6,601
40C21210	10	65	2.1/2"	100	3,610
40C21215	10	65	2.1/2"	150	4,600
40C21220	10	65	2.1/2"	200	6,289
40C21225	10	65	2.1/2"	250	7,738
40C21230	10	65	2.1/2"	300	8,920

## Art. 40 TRONCHETTI BLACK STUB ENDS



Tubo laminato **EN 10255**. Normale **UNI 339 - 7/1** per tubazioni **a tenuta** sul filetto. A richiesta si eseguono con filettatura cilindrica per tubazioni **non a tenuta** sul filetto **ISO 228 - UNI 338**.

**M** Fe 37 - EN 10255



Neri

**N** EN 10255 - Filetto ISO 7/1



Scatole di cartone

Si eseguono misure e lunghezze a richiesta non elencate nelle seguenti tabelle.

CODE	CONF.	DN	TYPE	LUNGH. mm	€
<b>40C31000</b>	10	80	3"	100	4,973
<b>40C31500</b>	10	80	3"	150	7,337
<b>40C32000</b>	10	80	3"	200	9,453
<b>40C32500</b>	10	80	3"	250	11,565
<b>40C33000</b>	10	80	3"	300	13,625
<b>40C41000</b>	10	100	4"	100	8,117
<b>40C41500</b>	10	100	4"	150	11,284
<b>40C42000</b>	10	100	4"	200	14,312
<b>40C42500</b>	10	100	4"	250	17,570
<b>40C43000</b>	10	100	4"	300	20,750

## Art. 41N BARILOTTI NERI BLACK EXTENSION SCREWS



Tubo laminato EN 10255. Normale UNI 339 - 7/1 per tubazioni a tenuta sul filetto.  
A richiesta si eseguono con filettatura cilindrica per tubazioni non a tenuta  
sul filetto ISO 228 - UNI 338.

**M** Fe 37 - EN 10255



Neri

**N** EN 10255 - Filetto ISO 7/1



Scatole di cartone

Si eseguono misure e lunghezze a richiesta non elencate nelle seguenti tabelle.

CODE	CONF.	DN	TYPE	LUNGH. mm	€
41N38001	10	10	3/8"	60	0,825
41N38002	10	10	3/8"	80	0,943
41N38003	10	10	3/8"	100	1,004
41N38004	10	10	3/8"	120	1,293
41N38005	10	10	3/8"	150	1,383
41N38006	10	10	3/8"	200	1,762
41N38007	10	10	3/8"	250	2,208
41N38008	10	10	3/8"	300	2,431
41N38009	10	10	3/8"	350	2,877
41N38010	10	10	3/8"	400	2,984
41N38011	10	10	3/8"	450	3,167
41N38012	10	10	3/8"	500	3,320
41N12001	10	15	1/2"	60	0,847
41N12002	10	15	1/2"	80	0,892
41N12003	10	15	1/2"	100	1,004
41N12004	10	15	1/2"	120	1,150
41N12005	10	15	1/2"	150	1,270
41N12006	10	15	1/2"	200	1,771
41N12007	10	15	1/2"	250	2,214
41N12008	10	15	1/2"	300	2,431
41N12009	10	15	1/2"	350	2,788
41N12010	10	15	1/2"	400	2,966
41N12011	10	15	1/2"	450	3,278
41N12012	10	15	1/2"	500	3,987
41N34001	10	20	3/4"	60	0,981
41N34002	10	20	3/4"	80	1,048
41N34003	10	20	3/4"	100	1,160
41N34004	10	20	3/4"	120	1,360
41N34005	10	20	3/4"	150	1,473
41N34006	10	20	3/4"	200	1,847
41N34007	10	20	3/4"	250	2,386
41N34008	10	20	3/4"	300	2,743
41N34009	10	20	3/4"	350	3,523
41N34010	10	20	3/4"	400	3,915
41N34011	10	20	3/4"	450	4,683
41N34012	10	20	3/4"	500	5,878

## Art. 41N BARILOTTI NERI BLACK EXTENSION SCREWS



Tubo laminato **EN 10255**. Normale **UNI 339 - 7/1** per tubazioni **a tenuta** sul filetto.  
A richiesta si eseguono con filettatura cilindrica per tubazioni **non a tenuta**  
sul filetto **ISO 228 - UNI 338**.

**M** Fe 37 - EN 10255



Neri

**N** EN 10255 - Filetto ISO 7/1



Scatole di cartone

Si eseguono misure e lunghezze a richiesta non elencate nelle seguenti tabelle.

CODE	CONF.	DN	TYPE	LUNGH. mm	€
41N10001	10	25	1"	60	1,182
41N10002	10	25	1"	80	1,383
41N10003	10	25	1"	100	1,539
41N10004	10	25	1"	120	1,890
41N10005	10	25	1"	150	2,141
41N10006	10	25	1"	200	2,721
41N10007	10	25	1"	250	3,189
41N10008	10	25	1"	300	3,746
41N10009	10	25	1"	350	4,638
41N10010	10	25	1"	400	4,906
41N10011	10	25	1"	450	5,352
41N10012	10	25	1"	500	6,021
41N11401	10	32	1.1/4"	60	1,606
41N11402	10	32	1.1/4"	80	1,695
41N11403	10	32	1.1/4"	100	1,940
41N11404	10	32	1.1/4"	120	2,453
41N11405	10	32	1.1/4"	150	2,542
41N11406	10	32	1.1/4"	200	3,300
41N11407	10	32	1.1/4"	250	3,880
41N11408	10	32	1.1/4"	300	4,683
41N11409	10	32	1.1/4"	350	5,753
41N11410	10	32	1.1/4"	400	6,021
41N11411	10	32	1.1/4"	450	6,913
41N11412	10	32	1.1/4"	500	7,448
41N11201	10	40	1.1/2"	60	1,918
41N11202	10	40	1.1/2"	80	2,096
41N11203	10	40	1.1/2"	100	2,431
41N11204	10	40	1.1/2"	120	3,144
41N11205	10	40	1.1/2"	150	3,457
41N11206	10	40	1.1/2"	200	4,059
41N11207	10	40	1.1/2"	250	4,795
41N11208	10	40	1.1/2"	300	5,575
41N11209	10	40	1.1/2"	350	7,136
41N11210	10	40	1.1/2"	400	7,359
41N11211	10	40	1.1/2"	450	8,697
41N11212	10	40	1.1/2"	500	9,277

## Art. 41N BARILOTTI NERI BLACK EXTENSION SCREWS



Tubo laminato EN 10255. Normale UNI 339 - 7/1 per tubazioni a tenuta sul filetto.  
A richiesta si eseguono con filettatura cilindrica per tubazioni non a tenuta  
sul filetto ISO 228 - UNI 338.

**M** Fe 37 - EN 10255



Neri

**N** EN 10255 - Filetto ISO 7/1



Scatole di cartone

Si eseguono misure e lunghezze a richiesta non elencate nelle seguenti tabelle.

CODE	CONF.	DN	TYPE	LUNGH. mm	€
41N20001	10	50	2"	60	2,542
41N20002	10	50	2"	80	2,676
41N20003	10	50	2"	100	3,122
41N20004	10	50	2"	120	3,925
41N20005	10	50	2"	150	4,081
41N20006	10	50	2"	200	5,263
41N20007	10	50	2"	250	6,244
41N20008	10	50	2"	300	7,404
41N20009	10	50	2"	350	8,920
41N20010	10	50	2"	400	9,366
41N20011	10	50	2"	450	10,927
41N20012	10	50	2"	500	11,819
41N21202	10	65	2.1/2"	80	3,412
41N21203	10	65	2.1/2"	100	4,237
41N21204	10	65	2.1/2"	120	5,174
41N21205	10	65	2.1/2"	150	5,397
41N21206	10	65	2.1/2"	200	6,913
41N21207	10	65	2.1/2"	250	8,251
41N21208	10	65	2.1/2"	300	9,812
41N21209	10	65	2.1/2"	350	12,042
41N21210	10	65	2.1/2"	400	13,380
41N21211	10	65	2.1/2"	450	15,387
41N21212	10	65	2.1/2"	500	17,617
41N30002	10	80	3"	80	4,906
41N30003	10	80	3"	100	5,464
41N30004	10	80	3"	120	7,359
41N30005	10	80	3"	150	7,805
41N30006	10	80	3"	200	10,035
41N30007	10	80	3"	250	12,265
41N30008	10	80	3"	300	14,495
41N30009	10	80	3"	350	17,528
41N30010	10	80	3"	400	18,955
41N30011	10	80	3"	450	23,415
41N30012	10	80	3"	500	25,645

## Art. 41N BARILOTTI NERI BLACK EXTENSION SCREWS



Tubo laminato **EN 10255**. Normale **UNI 339 - 7/1** per tubazioni **a tenuta** sul filetto.  
A richiesta si eseguono con filettatura cilindrica per tubazioni **non a tenuta**  
sul filetto **ISO 228 - UNI 338**.

**M** Fe 37 - EN 10255



Neri

**N** EN 10255 - Filetto ISO 7/1



Scatole di cartone

Si eseguono misure e lunghezze a richiesta non elencate nelle seguenti tabelle.

CODE	CONF.	DN	TYPE	LUNGH. mm	€
41N40002	10	100	4"	80	8,697
41N40003	10	100	4"	100	9,143
41N40004	10	100	4"	120	12,042
41N40005	10	100	4"	150	13,157
41N40006	10	100	4"	200	16,725
41N40007	10	100	4"	250	20,516
41N40008	10	100	4"	300	23,415
41N40009	10	100	4"	350	26,760
41N40010	10	100	4"	400	30,997
41N40011	10	100	4"	450	35,457
41N40012	10	100	4"	500	39,025

## Art. 41Z BARILOTTI ZINCATI GALVANIZED EXTENSION SCREWS



Tubo laminato EN 10255. Normale UNI 339 - 7/1 per tubazioni a tenuta sul filetto.  
A richiesta si eseguono con filettatura cilindrica per tubazioni non a tenuta  
sul filetto ISO 228 - UNI 338.

**M** Fe 37 - EN 10255  
Zincati a caldo

**N** EN 10255 - Filetto ISO 7/1  
Scatole di cartone

Si eseguono misure e lunghezze a richiesta non elencate nelle seguenti tabelle.

CODE	CONF.	DN	TYPE	LUNGH. mm	€
41Z38001	10	10	3/8"	60	0,914
41Z38002	10	10	3/8"	80	1,110
41Z38003	10	10	3/8"	100	1,210
41Z38004	10	10	3/8"	120	1,494
41Z38005	10	10	3/8"	150	1,620
41Z38006	10	10	3/8"	200	1,850
41Z38007	10	10	3/8"	250	2,676
41Z38008	10	10	3/8"	300	3,050
41Z38009	10	10	3/8"	350	3,367
41Z38010	10	10	3/8"	400	3,780
41Z38011	10	10	3/8"	450	3,969
41Z38012	10	10	3/8"	500	4,520
41Z38013	10	10	3/8"	750	7,805
41Z38014	10	10	3/8"	1000	10,927
41Z38015	10	10	3/8"	1250	12,488
41Z38016	10	10	3/8"	1500	13,826
41Z38017	10	10	3/8"	2000	15,850
41Z38018	10	10	3/8"	2500	24,976
41Z38019	10	10	3/8"	3000	31,220
41Z12001	10	15	1/2"	60	0,886
41Z12002	10	15	1/2"	80	1,048
41Z12003	10	15	1/2"	100	1,080
41Z12004	10	15	1/2"	120	1,429
41Z12005	10	15	1/2"	150	1,425
41Z12006	10	15	1/2"	200	1,760
41Z12007	10	15	1/2"	250	2,453
41Z12008	10	15	1/2"	300	2,810
41Z12009	10	15	1/2"	350	3,194
41Z12010	10	15	1/2"	400	3,635
41Z12011	10	15	1/2"	450	3,992
41Z12012	10	15	1/2"	500	4,215
41Z12013	10	15	1/2"	750	6,512
41Z12014	10	15	1/2"	1000	7,805
41Z12015	10	15	1/2"	1250	12,265
41Z12016	10	15	1/2"	1500	14,718
41Z12017	10	15	1/2"	2000	18,955
41Z12018	10	15	1/2"	2500	24,530
41Z12019	10	15	1/2"	3000	31,220



## Art. 41Z BARILOTTI ZINCATI GALVANIZED EXTENSION SCREWS



Tubo laminato EN 10255. Normale UNI 339 - 7/1 per tubazioni a tenuta sul filetto.  
A richiesta si eseguono con filettatura cilindrica per tubazioni non a tenuta  
sul filetto ISO 228 - UNI 338.

**M** Fe 37 - EN 10255



**N** EN 10255 - Filetto ISO 7/1



Scatole di cartone

Si eseguono misure e lunghezze a richiesta non elencate nelle seguenti tabelle.

CODE	CONF.	DN	TYPE	LUNGH. mm	€
41Z34001	10	20	3/4"	60	1,051
41Z34002	10	20	3/4"	80	1,175
41Z34003	10	20	3/4"	100	1,320
41Z34004	10	20	3/4"	120	1,678
41Z34005	10	20	3/4"	150	1,687
41Z34006	10	20	3/4"	200	2,097
41Z34007	10	20	3/4"	250	2,788
41Z34008	10	20	3/4"	300	3,278
41Z34009	10	20	3/4"	350	3,969
41Z34010	10	20	3/4"	400	4,192
41Z34011	10	20	3/4"	450	4,906
41Z34012	10	20	3/4"	500	5,508
41Z34013	10	20	3/4"	750	7,805
41Z34014	10	20	3/4"	1000	10,035
41Z34015	10	20	3/4"	1250	15,387
41Z34016	10	20	3/4"	1500	17,394
41Z34017	10	20	3/4"	2000	23,680
41Z34018	10	20	3/4"	2500	32,335
41Z34019	10	20	3/4"	3000	37,910
41Z10001	10	25	1"	60	1,338
41Z10002	10	25	1"	80	1,606
41Z10003	10	25	1"	100	1,691
41Z10004	10	25	1"	120	2,050
41Z10005	10	25	1"	150	2,243
41Z10006	10	25	1"	200	2,818
41Z10007	10	25	1"	250	3,746
41Z10008	10	25	1"	300	4,282
41Z10009	10	25	1"	350	5,419
41Z10010	10	25	1"	400	5,664
41Z10011	10	25	1"	450	6,229
41Z10012	10	25	1"	500	7,136
41Z10013	10	25	1"	750	11,596
41Z10014	10	25	1"	1000	15,164
41Z10015	10	25	1"	1250	22,077
41Z10016	10	25	1"	1500	26,314
41Z10017	10	25	1"	2000	36,572
41Z10018	10	25	1"	2500	45,715
41Z10019	10	25	1"	3000	54,635

## Art. 41Z BARILOTTI ZINCATI GALVANIZED EXTENSION SCREWS



Tubo laminato EN 10255. Normale UNI 339 - 7/1 per tubazioni a tenuta sul filetto.  
A richiesta si eseguono con filettatura cilindrica per tubazioni non a tenuta  
sul filetto ISO 228 - UNI 338.

**M** Fe 37 - EN 10255

 Zincati a caldo

**N** EN 10255 - Filetto ISO 7/1

 Scatole di cartone

Si eseguono misure e lunghezze a richiesta non elencate nelle seguenti tabelle.

CODE	CONF.	DN	TYPE	LUNGH. mm	€
41Z11401	10	32	1.1/4"	60	1,896
41Z11402	10	32	1.1/4"	80	1,962
41Z11403	10	32	1.1/4"	100	2,163
41Z11404	10	32	1.1/4"	120	2,685
41Z11405	10	32	1.1/4"	150	3,011
41Z11406	10	32	1.1/4"	200	3,746
41Z11407	10	32	1.1/4"	250	4,683
41Z11408	10	32	1.1/4"	300	5,352
41Z11409	10	32	1.1/4"	350	6,021
41Z11410	10	32	1.1/4"	400	7,091
41Z11411	10	32	1.1/4"	450	7,905
41Z11412	10	32	1.1/4"	500	8,764
41Z11413	10	32	1.1/4"	750	15,387
41Z11414	10	32	1.1/4"	1000	21,450
41Z11415	10	32	1.1/4"	1250	25,500
41Z11416	10	32	1.1/4"	1500	30,260
41Z11417	10	32	1.1/4"	2000	39,470
41Z11418	10	32	1.1/4"	2500	50,050
41Z11419	10	32	1.1/4"	3000	62,630
41Z11201	10	40	1.1/2"	60	2,230
41Z11202	10	40	1.1/2"	80	2,453
41Z11203	10	40	1.1/2"	100	2,698
41Z11204	10	40	1.1/2"	120	3,376
41Z11205	10	40	1.1/2"	150	3,791
41Z11206	10	40	1.1/2"	200	4,683
41Z11207	10	40	1.1/2"	250	5,687
41Z11208	10	40	1.1/2"	300	6,570
41Z11209	10	40	1.1/2"	350	7,869
41Z11210	10	40	1.1/2"	400	9,143
41Z11211	10	40	1.1/2"	450	9,735
41Z11212	10	40	1.1/2"	500	11,150
41Z11213	10	40	1.1/2"	750	18,955
41Z11214	10	40	1.1/2"	1000	23,030
41Z11215	10	40	1.1/2"	1250	30,805
41Z11216	10	40	1.1/2"	1500	32,500
41Z11217	10	40	1.1/2"	2000	43,700
41Z11218	10	40	1.1/2"	2500	60,148
41Z11219	10	40	1.1/2"	3000	69,700

## Art. 41Z BARILOTTI ZINCATI GALVANIZED EXTENSION SCREWS



Tubo laminato EN 10255. Normale UNI 339 - 7/1 per tubazioni a tenuta sul filetto.  
A richiesta si eseguono con filettatura cilindrica per tubazioni non a tenuta  
sul filetto ISO 228 - UNI 338.

**M** Fe 37 - EN 10255



**N** EN 10255 - Filetto ISO 7/1



Scatole di cartone

Si eseguono misure e lunghezze a richiesta non elencate nelle seguenti tabelle.

CODE	CONF.	DN	TYPE	LUNGH. mm	€
41Z20001	10	50	2"	60	2,890
41Z20002	10	50	2"	80	3,234
41Z20003	10	50	2"	100	3,410
41Z20004	10	50	2"	120	4,305
41Z20005	10	50	2"	150	4,683
41Z20006	10	50	2"	200	5,750
41Z20007	10	50	2"	250	7,136
41Z20008	10	50	2"	300	8,697
41Z20009	10	50	2"	350	10,860
41Z20010	10	50	2"	400	11,039
41Z20011	10	50	2"	450	12,483
41Z20012	10	50	2"	500	13,826
41Z20013	10	50	2"	750	26,537
41Z20014	10	50	2"	1000	29,400
41Z20015	10	50	2"	1250	37,977
41Z20016	10	50	2"	1500	42,110
41Z20017	10	50	2"	2000	55,300
41Z20018	10	50	2"	2500	78,821
41Z20019	10	50	2"	3000	94,600
41Z21202	10	65	2.1/2"	80	4,126
41Z21203	10	65	2.1/2"	100	4,683
41Z21204	10	65	2.1/2"	120	6,155
41Z21205	10	65	2.1/2"	150	6,467
41Z21206	10	65	2.1/2"	200	8,028
41Z21207	10	65	2.1/2"	250	10,258
41Z21208	10	65	2.1/2"	300	11,373
41Z21209	10	65	2.1/2"	350	14,339
41Z21210	10	65	2.1/2"	400	14,941
41Z21211	10	65	2.1/2"	450	15,833
41Z21212	10	65	2.1/2"	500	19,847
41Z21213	10	65	2.1/2"	750	33,963
41Z21214	10	65	2.1/2"	1000	39,181
41Z21215	10	65	2.1/2"	1250	48,976
41Z21216	10	65	2.1/2"	1500	58,772
41Z21217	10	65	2.1/2"	2000	78,362
41Z21218	10	65	2.1/2"	2500	97,953
41Z21219	10	65	2.1/2"	3000	117,543

## Art. 41Z BARILOTTI ZINCATI GALVANIZED EXTENSION SCREWS



Tubo laminato EN 10255. Normale UNI 339 - 7/1 per tubazioni a tenuta sul filetto.  
A richiesta si eseguono con filettatura cilindrica per tubazioni non a tenuta  
sul filetto ISO 228 - UNI 338.

**M** Fe 37 - EN 10255

 Zincati a caldo

**N** EN 10255 - Filetto ISO 7/1

 Scatole di cartone

Si eseguono misure e lunghezze a richiesta non elencate nelle seguenti tabelle.

CODE	CONF.	DN	TYPE	LUNGH. mm	€
41Z30002	10	80	3"	80	5,597
41Z30003	10	80	3"	100	6,467
41Z30004	10	80	3"	120	8,809
41Z30005	10	80	3"	150	9,143
41Z30006	10	80	3"	200	11,819
41Z30007	10	80	3"	250	14,495
41Z30008	10	80	3"	300	16,050
41Z30009	10	80	3"	350	20,202
41Z30010	10	80	3"	400	20,900
41Z30011	10	80	3"	450	25,491
41Z30012	10	80	3"	500	25,600
41Z30013	10	80	3"	750	46,161
41Z30014	10	80	3"	1000	56,387
41Z30015	10	80	3"	1250	71,534
41Z30016	10	80	3"	1500	83,625
41Z30017	10	80	3"	2000	111,500
41Z30018	10	80	3"	2500	139,375
41Z30019	10	80	3"	3000	167,250
41Z40002	10	100	4"	80	9,366
41Z40003	10	100	4"	100	11,373
41Z40004	10	100	4"	120	14,718
41Z40005	10	100	4"	150	15,610
41Z40006	10	100	4"	200	18,160
41Z40007	10	100	4"	250	20,790
41Z40008	10	100	4"	300	24,800
41Z40009	10	100	4"	350	29,800
41Z40010	10	100	4"	400	33,700
41Z40011	10	100	4"	450	38,761
41Z40012	10	100	4"	500	40,800
41Z40013	10	100	4"	750	64,670
41Z40014	10	100	4"	1000	78,050
41Z40015	10	100	4"	1250	109,270
41Z40016	10	100	4"	1500	117,985
41Z40017	10	100	4"	2000	156,100
41Z40018	10	100	4"	2500	195,236
41Z40019	10	100	4"	3000	272,060

## Art. 42 SCORREVOLI GALVANIZED SLIDING EXTENSION SCREWS



Si eseguono misure e lunghezze a richiesta non elencate nelle seguenti tabelle.

Filetto corto conico - filetto lungo cilindrico  
Tubo laminato **EN 10255** - Filetto conico **UNI 339 - 7/1**  
Filetto cilindrico **UNI 338 - ISO 228**

A richiesta si eseguono con filettatura cilindrica per tubazioni  
**non a tenuta** sul filetto **ISO 228 - UNI 338**.

**M** Fe 37 - EN 10255

 Zincati a caldo

**N** EN 10255 Filetto UNI 339  
Filetto cilindr. - UNI 338 - ISO 228

 Scatole di cartone

CODE	CONF.	DN	TYPE	LUNGH. mm	€
42C38100	10	10	3/8"	100	1,271
42C38130	10	10	3/8"	120	1,650
42C38150	10	10	3/8"	150	1,767
42C38200	10	10	3/8"	200	2,230
42C12100	10	15	1/2"	100	1,494
42C12130	10	15	1/2"	120	1,896
42C12150	10	15	1/2"	150	1,985
42C12200	10	15	1/2"	200	2,475
42C34100	10	20	3/4"	100	1,784
42C34130	10	20	3/4"	120	2,163
42C34150	10	20	3/4"	150	2,297
42C34200	10	20	3/4"	200	2,877
42C11000	10	25	1"	100	2,342
42C11300	10	25	1"	120	2,813
42C11500	10	25	1"	150	3,011
42C12000	10	25	1"	200	3,925
42C11410	10	32	1.1/4"	100	2,631
42C11413	10	32	1.1/4"	120	3,406
42C11415	10	32	1.1/4"	150	3,590
42C11420	10	32	1.1/4"	200	4,393
42C11210	10	40	1.1/2"	100	3,300
42C11213	10	40	1.1/2"	120	4,304
42C11215	10	40	1.1/2"	150	4,572
42C11220	10	40	1.1/2"	200	5,820
42C21000	10	50	2"	100	4,683
42C21300	10	50	2"	120	5,508
42C21500	10	50	2"	150	5,731
42C22000	10	50	2"	200	7,582

## TRONCHETTI E BARILOTTI STUB ENDS AND EXTENSION SCREW

I tronchetti, barilotti e scorrevoli sono eseguiti con le seguenti caratteristiche:

- tubo laminato a caldo secondo normativa UNI 3824-68 serie normale corrispondente norma internazionale **ISO R 65**

- normalmente eseguito per tubazioni a tenuta sul filetto a norme **UNI 339 - ISO 7**

- a richiesta si eseguono con filettatura cilindrica per tubazioni non a tenuta sul filetto **ISO 228**

- la zincatura è solo a fuoco.

Oltre alle misure indicate in tabella si eseguono, a richiesta, qualsiasi dimensione e lunghezza.

### Filettatura gas conica UNI 339 - ISO 7 - DIN 2999 per tubaz. a tenuta sul filetto

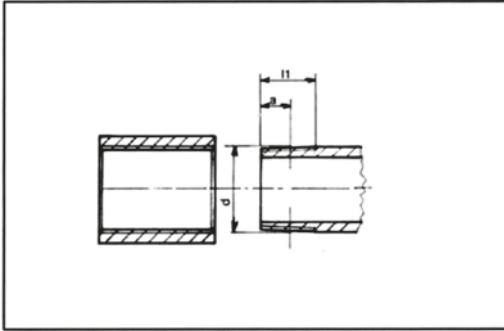

TYPE	Filetti per 1"	Ø d al piano a	Distanza		Lunghezza	
			a	Toll.	L1	a min.
3/8	19	16,66	6,4	1,3	10,1	9,856
1/2	14	20,95	8,2	1,8	13,2	12,768
3/4	14	26,44	9,5	1,8	14,5	14,336
1"	11	33,24	10,4	2,3	16,8	16,240
1"1/4	11	41,91	12,7	2,3	19,1	18,816
1"1/2	11	47,80	12,7	2,3	19,1	20,500
2"	11	59,61	15,9	2,3	23,4	23,632
2"1/2	11	75,18	17,5	3,5	26,7	25,984
3"	11	87,88	20,6	3,5	29,8	29,456
4"	11	113,03	25,4	3,5	35,8	36,176

### Filettatura gas cilindrica UNI 338 - ISO 228 - DIN 259

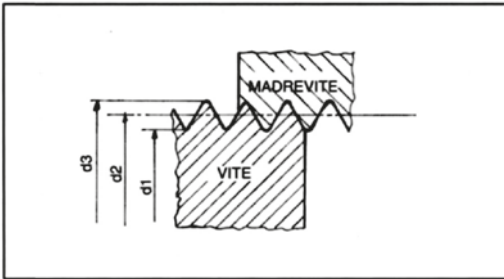

TYPE	Filetti per 1"	Nocciolo d1		Esterno d3	
		min	max	max	min
3/8	19	14,95	14,79	16,66	18,379
1/2	14	18,63	18,45	20,95	23,150
3/4	14	24,11	23,93	26,44	29,288
1"	11	30,29	30,06	33,24	36,826
1"1/4	11	38,95	38,72	41,91	46,536
1"1/2	11	44,84	44,62	47,80	53,133
2"	11	56,65	56,43	59,61	66,360
2"1/2	11	72,22	71,95	75,18	83,720
3"	11	84,92	84,65	87,88	97,944